



Beta Three

QS1000t

10" Two Way Full Range
Pro Speaker System

User Manual

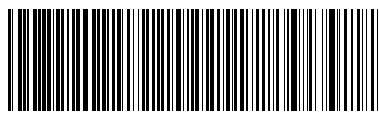
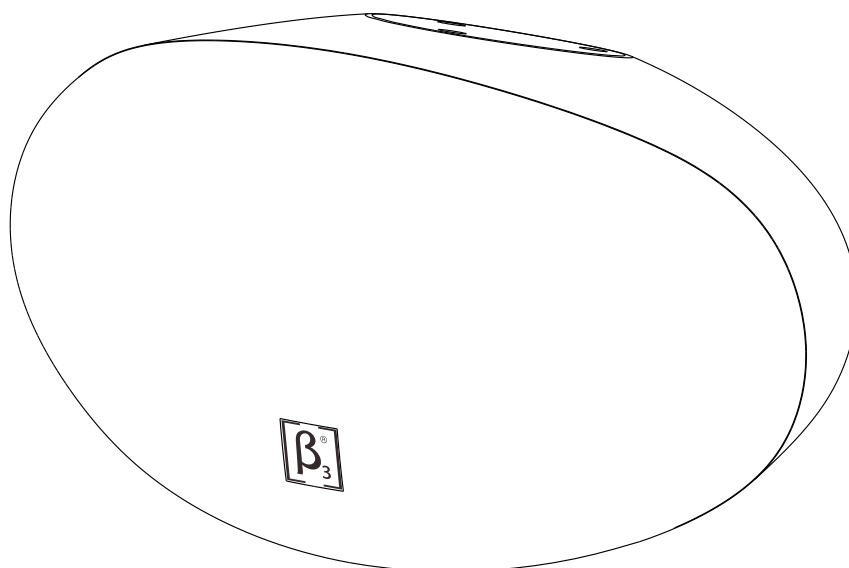
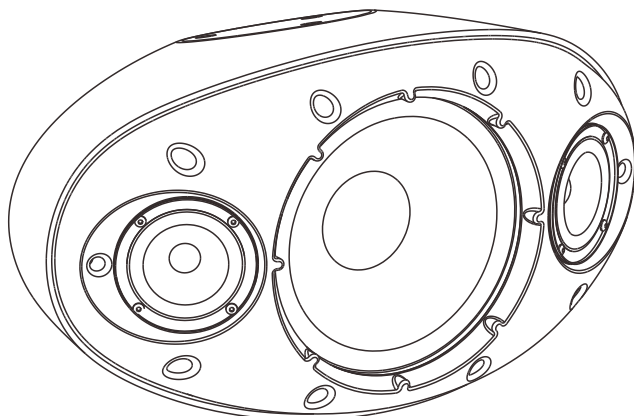



UM-QS1000t - 20120511 ver A



SAFETY INSTRUCTIONS

PLEASE READ THIS MANUAL FIRST

Thank you for a buying β_3 product. Read this manual first as it will help you operate the system properly. Please keep this manual for future reference.

⚠ WARNING: *This product must be installed by professionals. When using hanging brackets or rigging other than those supplied with the product, please ensure they comply with the local safety codes.*

	CAUTION RISK OF ELECTRICAL SHOCK DO NOT OPEN	
CAUTION: TO REDUCE THE RISK OF ELECTRIC SHOCK, DO NOT REMOVE COVER (OR BACK). NO USER-SERVICABLE PARTS INSIDE. REFER SERVICING TO QUALIFIED PERSONNEL.		

	AVIS RISQUE DE CHOC ÉLECTRIQUE NE PAS OUVRIR	
ATTENTION : POUR RÉDUIRE LE RISQUE DE DÉCHARGE ÉLECTRIQUE, NE RETIREZ PAS LE COUVERCLE (OU L'ARRIÈRE). IL NE SE TROUVE À L'INTÉRIEUR AUCUNE PIÈCE POUVANT ÊTRE RÉPARÉE PAR L'USAGER. S'ADRESSER À UN RÉPARATEUR COMPÉTENT.		

 *The exclamation point within an equilateral triangle is intended to alert you to the presence of important operating and servicing instructions.*

⚠ ATTENTION: *Don't refit the system or spare parts without being authorized as this will void the warranty.*

⚠ WARNING: *Don't place naked flames (such as candles) close to the equipment.*

1. Read the instruction manual first before using this product.
2. Please keep this manual for future reference
3. Pay attention to all warnings.
4. Obey all operating instructions.
5. Do not expose this product to rain or moisture.
6. Clean this equipment with a dry cloth.
7. Do not block any ventilation openings. Install according to manufacturer's instructions .
8. Do not install this product near any heat source, such as a, heater, burner, or any other equipment with heat radiation .
9. Only use spare parts supplied by the manufacturer.
10. Pay attention to the safety symbol on the outside of the cover.



CONTENT

INTRODUCTION	3
Features	3
Description	3
Applications	3
CONNECTION	4
Terminal Plate	4
System Connection Reference	4
INSTALLATION	5
Installation Accessories	5
Installation Reference	5
TECHNICAL SPECIFICATION	6
Technical Sheet	6
Frequency Response And Impedance Curve	6
2D Dimension	7

 Product information subjects to be updated without notification, please visit www.elderaudio.com for latest update.

QS1000t

10" Two Way Full Range Pro Speaker System

Features

- Two new 4-inch paper cone mid-high frequency drivers.
- 10-inch paper cone low frequency driver.
- High intensity injection moulding cabinet.
- Dispersion 120°x 120°.
- Frequency response 45 Hz-20k Hz (-3dB).
- Sensitivity 90dB, Max SPL 111 dB.
- 3 x M8 hang point.
- Customizable grill and cabinet color.

Description

QS1000t is a 10"2-way full range speaker system with wide dispersion. Its sound is nature and clear while the cabinet is handy, compact and the appearance elegant and fashionable. It's applicable in small and medium performing stages, KTV, multi-function halls as sound monitoring and major and fill sound reinforcement.

QS1000t adopts two 4-inch new paper cone high frequency speakers which greatly enhance the performance and power loading capacity in the mid-high frequencies. The optimized 10-inch low frequency driver can realize highest clearance and lowest distortion in high sound pressure. The 12 dB attenuation slope cross frequency circuit enables smooth frequency response. And the full range circuit protecting system provides higher security.

The cabinet is injection moulded with high intensity polypropylene. The delicate designed shape provides best structure strength and acoustic characteristics. The colors of grill and cabinet are available for customization.

Qs1000t adopts multifunctional structure design. It's applicable both in mobile and stage performance. Our special designed accessories with the 3 x M8 hanging point can be used in various installation requirements easily and conveniently.

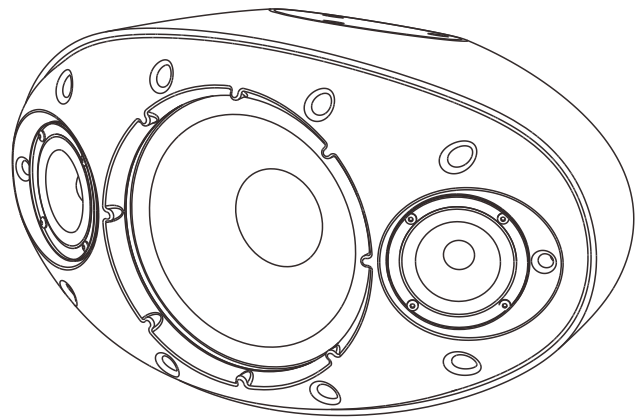
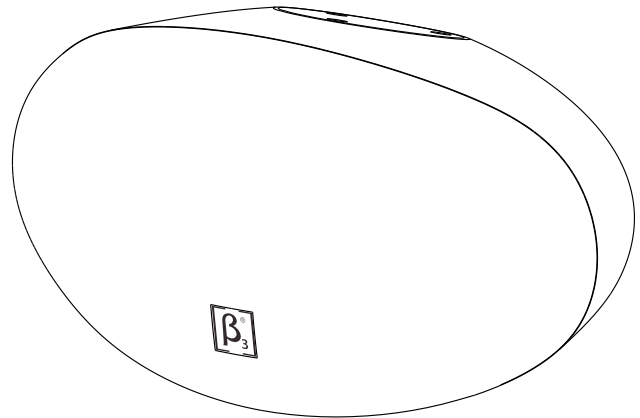

Applications

- KTV
- Monitor
- Public Avenue
- Small Performance
- Multifunction Rooms

QS1000t connects the amplifier with a wire clamp. Two groups of parallel terminals enable it to connect to another speaker conveniently.

Terminal Plate

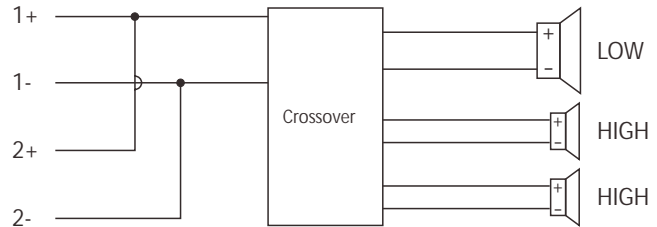
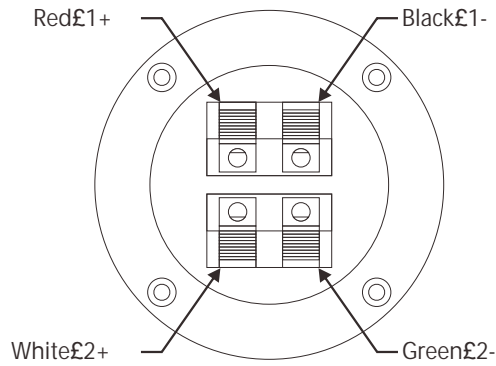

System Connection Reference

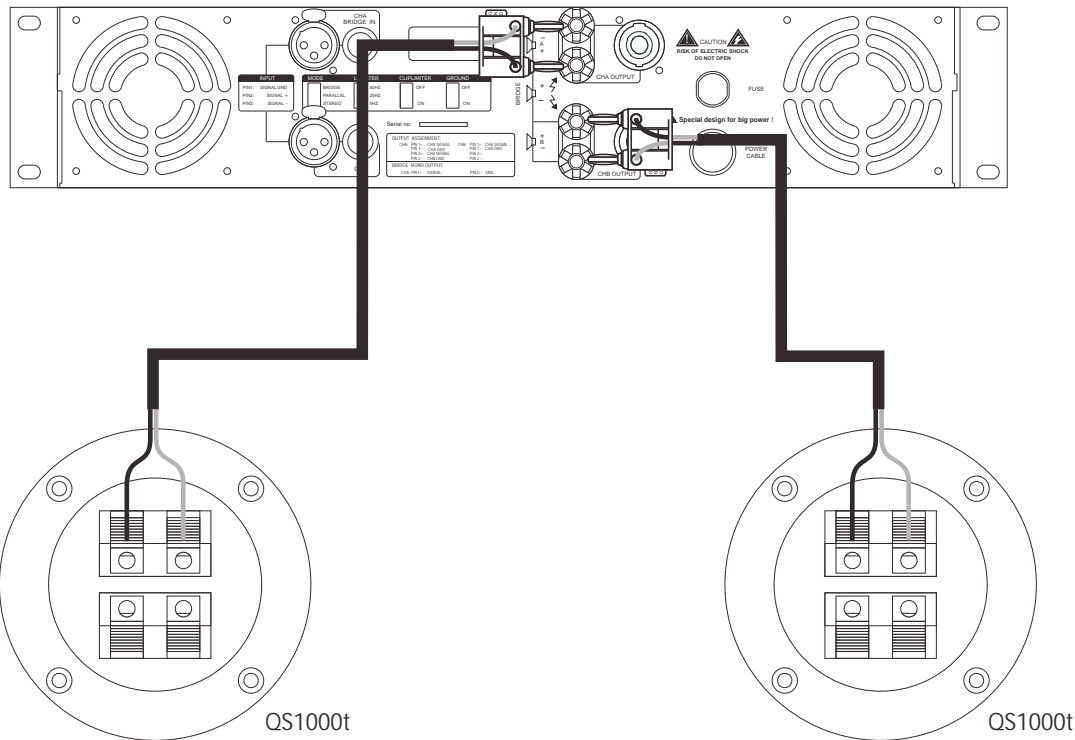

- Attention:** The impedance of connected speaker must match the impedance of amplifier output.
- Attention:** Make sure the polarity of speaker and amplifier correctly.

Installation Accessories

QS1000t has 3 hanging points to work together with the special designed accessories for fast and convenient hanging, wall-mounting and on standing with adjustable angles.

1. Hanging Bracket

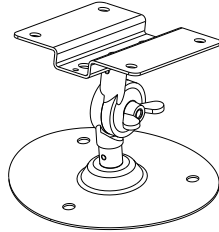

2. Wall Bracket

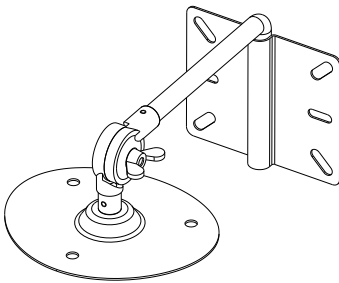

3. Standing Bracket

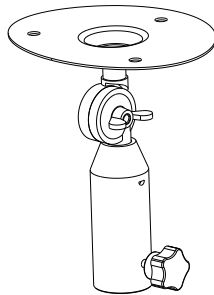

Installation Reference

1. Ceiling

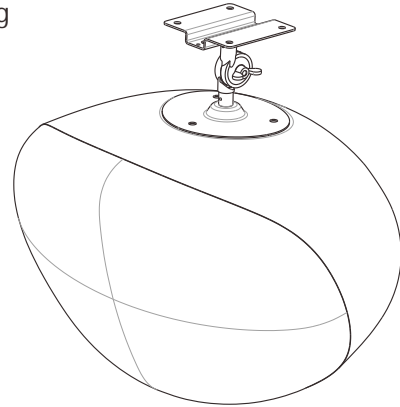

2. Wall

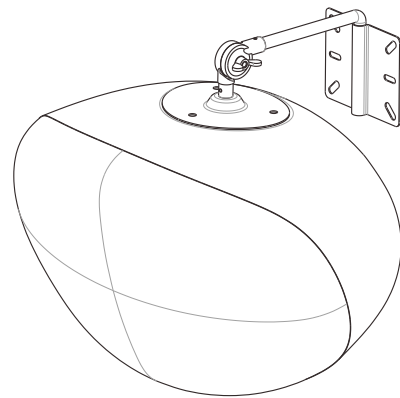

3. Support

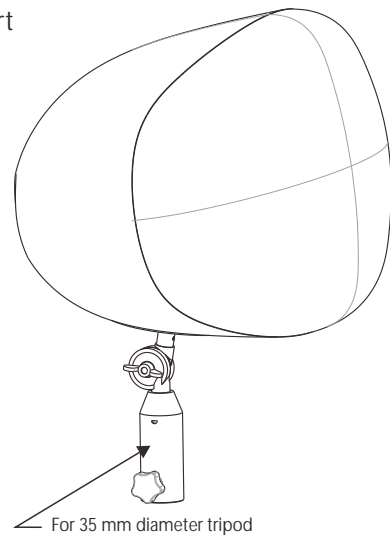

Warning: Make sure the mounting accessories safety factor not less than 5:1 or meet the local standard during installation .

Technical Sheet

System:	Two way full range speaker
Tweeter:	2 x4" High frequency drivers
Woofers:	1 x10" Woofer
Frequency response(-3dB): ¹	45Hz-20kHz
Frequency response(-10dB):	40Hz-24kHz
Sensitivity(1W@1m): ²	90dB
Max.SPL(1m): ³	117dB/123dB(PEAK)
Power:	150W (RMS) ⁴ 300W (MUSIC) 600W (PEAK)
Dispersion(H x V):	120° x120°
Rated impedance:	8 Ohms
Crossover point:	1.2 kHz
Cabinet:	Polypropylene injection moulding
Mounting accessories:	3 xM8 Bracket lifting point
Painting:	Cabinet Exterior with/without polyurethane spraying treatment (depends on colors)Grill with cloth
Connector:	Wire clamp
Cabinet dimension: (W x D x H)	550mmx316mmx336mm (21.5inx12.4inx13.2in)
Package dimension: (W x D x H)	620mmx385mmx425mm (24.4inx15inx16.7in)
N.W.(pc):	10.5kg(23.1 lb.)
G.W.(pc):	12.5kg(27.5 lb.)

Speaker Testing Method

1. Frequency response

Use Pink noise to test the speaker in the anechoic room, adjust the level to make the speaker work at its rated impedance and the power output is 1W, then test the frequency response 1m away from the speaker.

2. Sensitivity

Use full range Pink noise which was modified by EQ curve to test the speaker in the anechoic room, enlarge the signal to make the speaker work at its rated impedance and the power output is 1W, then test the sensitivity 1m away from the speaker.

3. MAX.SPL

Use full range Pink noise which was modified by EQ curve to test the speaker in the anechoic room, enlarge the signal to make the speaker work at its instant power output level, then test the SPL 1m away from the speaker.

4. Rated Power

Use the pink noise according to IEC#268-5 to test the speaker, enlarge the signal for continuous 100hours, the rated Power is the power when the speaker will not incur hot damage or mechanics damage.

Frequency Response And Impedance Curve

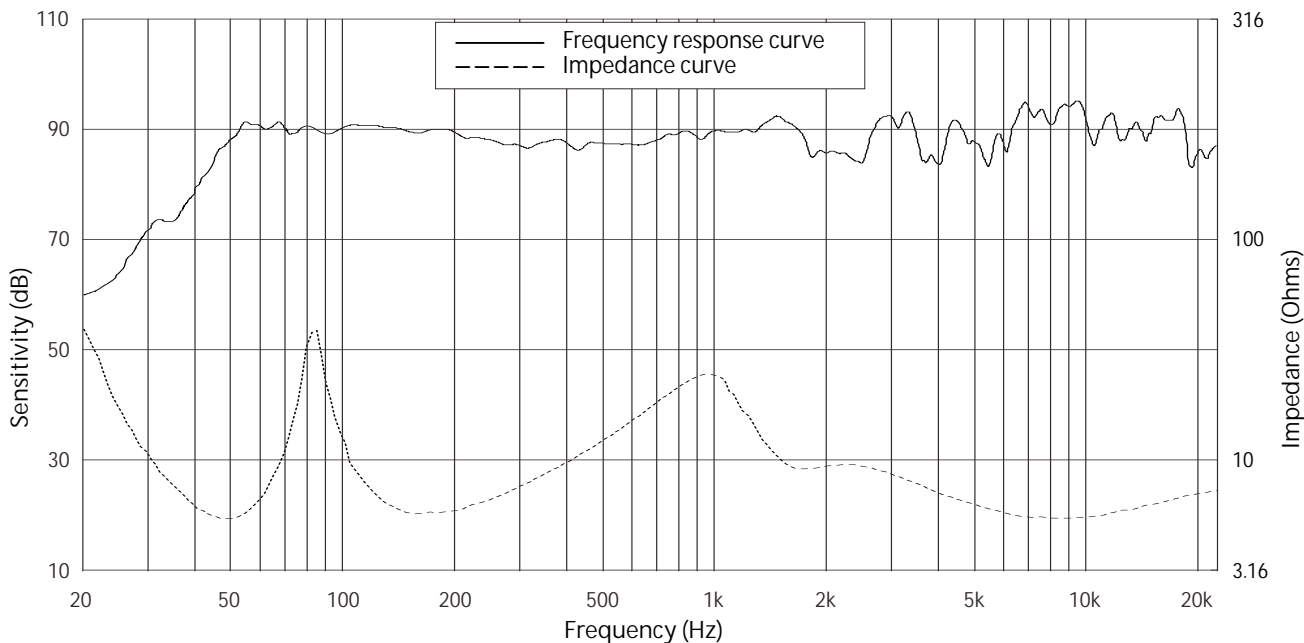

2D Dimension

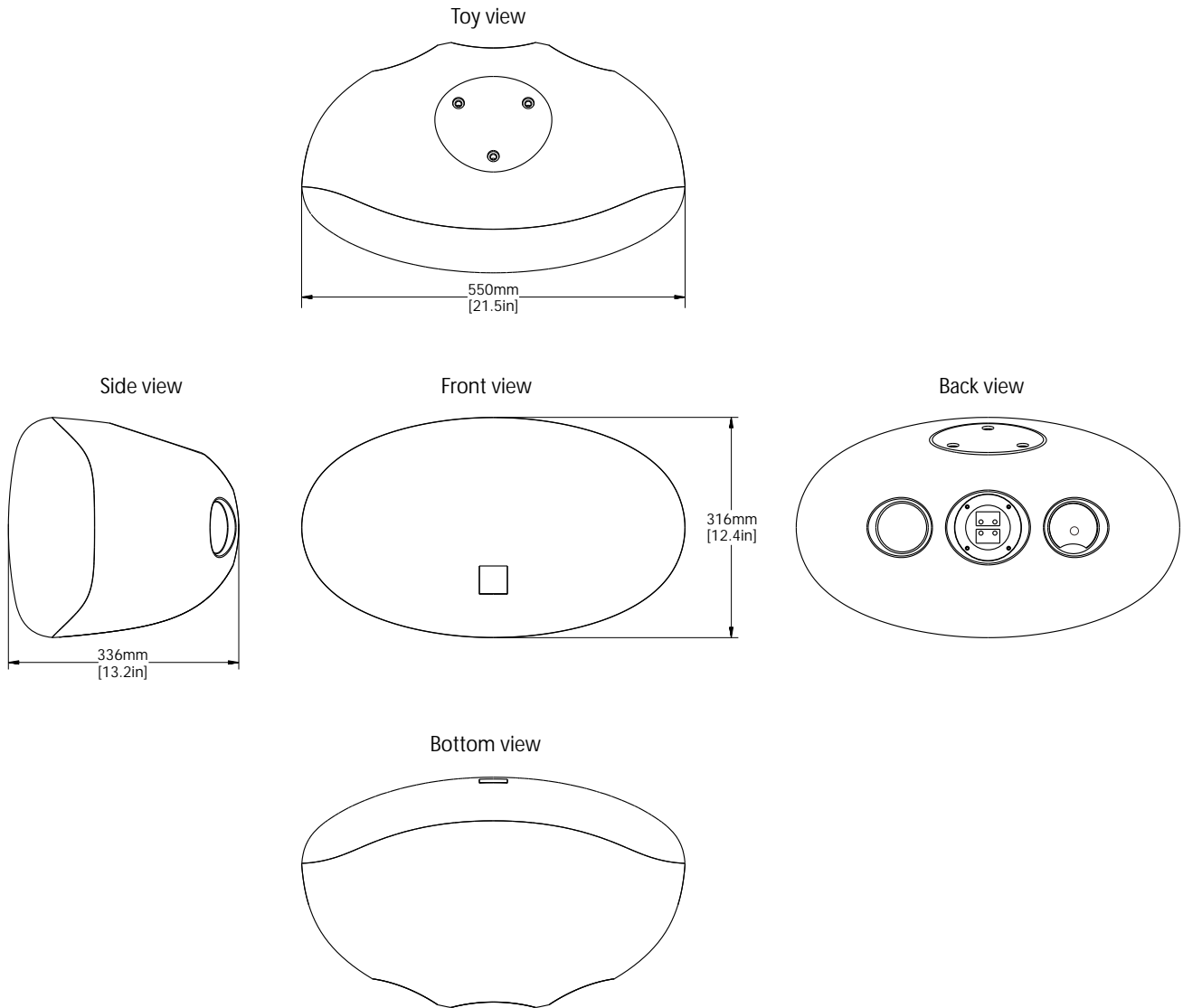

Notes:



Beta Three