



Beta Three

T12a

Two Way 12" Full Range
Active Speaker

THUNDER Series Pro Loudspeaker System

User Manual

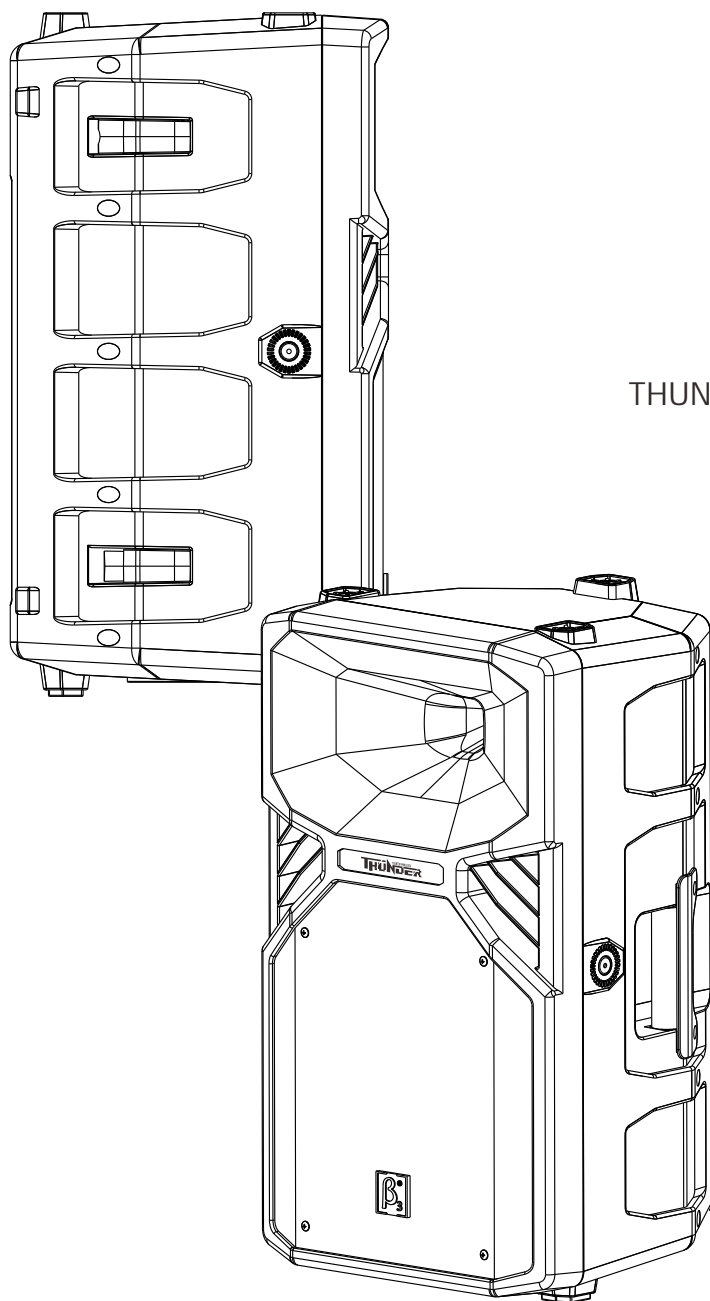



UM-T12a-20121105 ver C



SAFETY INSTRUCTIONS

PLEASE READ THIS MANUAL FIRST

Thank you for a buying β_3 product. Read this manual first as it will help you operate the system properly. Please keep this manual for future reference.

⚠ WARNING: *This product must be installed by professionals. When using hanging brackets or rigging other than those supplied with the product, please ensure they comply with the local safety codes.*

	CAUTION RISK OF ELECTRICAL SHOCK DO NOT OPEN	
CAUTION: TO REDUCE THE RISK OF ELECTRIC SHOCK, DO NOT REMOVE COVER (OR BACK). NO USER-SERVICABLE PARTS INSIDE. REFER SERVICING TO QUALIFIED PERSONNEL.		

	AVIS RISQUE DE CHOC ÉLECTRIQUE NE PAS OUVRIR	
ATTENTION : POUR RÉDUIRE LE RISQUE DE DÉCHARGE ÉLECTRIQUE, NE RETIREZ PAS LE COUVERCLE (OU L'ARRIÈRE). IL NE SE TROUVE À L'INTÉRIEUR AUCUNE PIÈCE POUVANT ÊTRE RÉPARÉE PAR L'USAGER. S'ADRESSER À UN RÉPARATEUR COMPÉTENT.		

 *The exclamation point within an equilateral triangle is intended to alert you to the presence of important operating and servicing instructions.*

⚠ ATTENTION: *Don't refit the system or spare parts without being authorized as this will void the warranty.*

⚠ WARNING: *Don't place naked flames (such as candles) close to the equipment.*

1. Read the instruction manual first before using this product.
2. Please keep this manual for future reference
3. Pay attention to all warnings.
4. Obey all operating instructions.
5. Do not expose this product to rain or moisture.
6. Clean this equipment with a dry cloth.
7. Do not block any ventilation openings. Install according to manufacturer's instructions .
8. Do not install this product near any heat source, such as a, heater, burner, or any other equipment with heat radiation .
9. Only use spare parts supplied by the manufacturer.
10. Pay attention to the safety symbol on the outside of the cover.

CONTENT

INTRODUCTION	3
Features	3
Description	3
Applications	3
AMPLIFIER MODULE	4
Amplifier Module	4
INSTALLATION	5
Mounting Accessories	5
Installation Reference	5
TECHNICAL SPECIFICATION	6
Technical Sheet	6
Frequency Response and Impedance Curve	6
2D Dimension	7

T12a

Two Way 12" Full Range Active Speaker

Features

- Compact lightweight design with unique appearance.
- New generation Class D amplifier, durable and reliable.
- Performance enhanced with built-in DSP.
- Heavy duty powered coated steel grill.
- 35mm SMART pole mount for vertical and 5 ° downward tilt.
- Integrated feet for stage monitor applications.
- M8 rigging points for convenient installation.

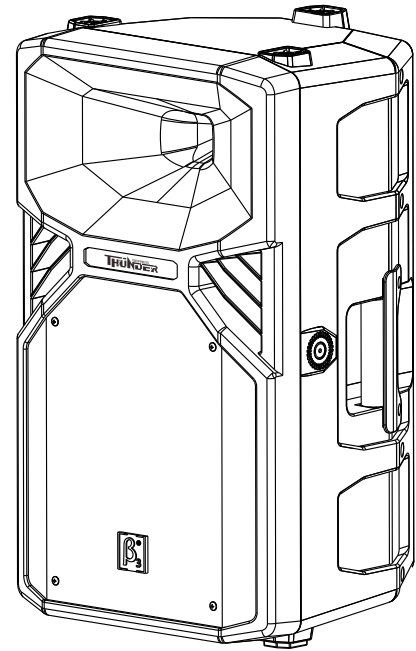

Description

T12a Thunder series is designed for portable and installed applications. The integrated polymer PVC cabinet design ensures durability and full natural high performance sound.

3[®] T12a is a full range active speaker with a 1100W Class D amplifier module. The high powered 12" woofer delivers powerful low frequency and the 1.7" Titanium compression driver delivers high definition mid/high frequencies.

Rigging points and SMART pole mount makes for easy installation or portable use.

Applications

- Church
- Auditorium
- Conference room
- Small performance
- Multifunctional hall

Rear Panel Amplifier Module

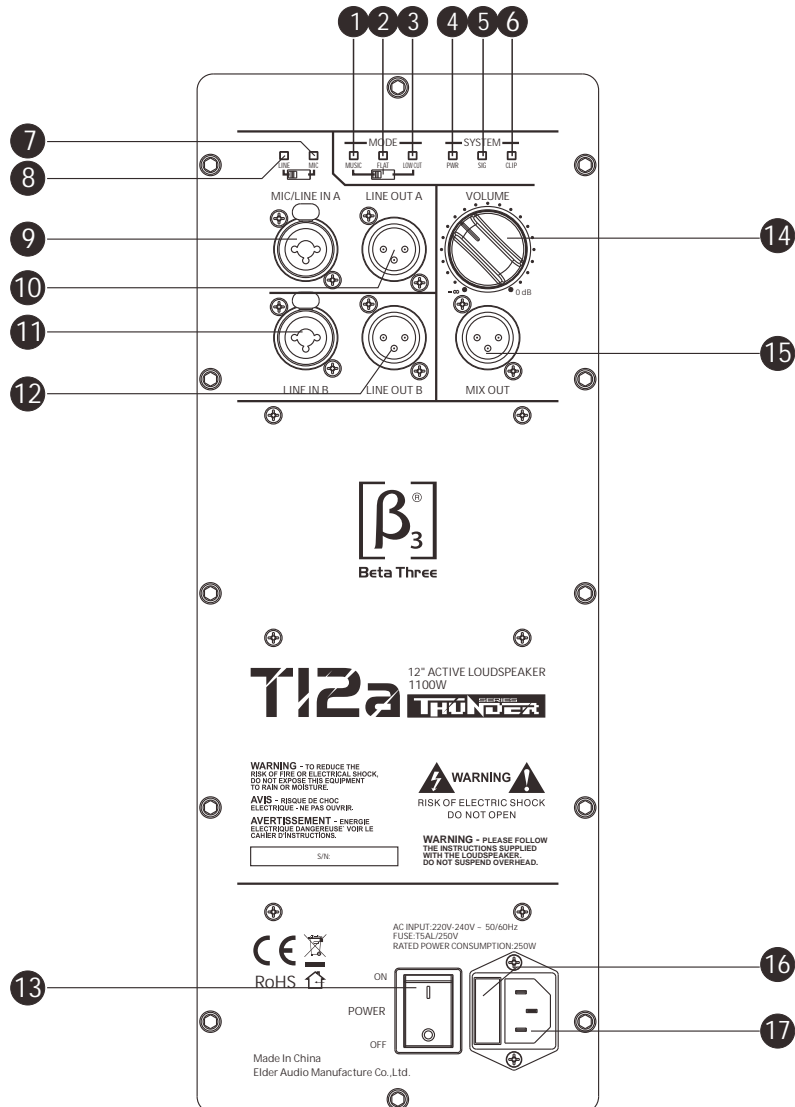

- | | | |
|---------------------------------------|---------------------------------|---|
| 1. Music mode | 8. Line input signal indicator. | 15. MIX output. |
| 2. Flat mode | 9. Line/microphone input A. | 16. Protection fuse. Use only fuse of the correct amp rating. |
| 3. Low cut mode | 10. Line/microphone output A. | 17. Power supply input. Make sure that the voltage is set for your country's correct voltage. |
| 4. Power indicator | 11. Line input B. | |
| 5. Signal indicator | 12. Line output B. | |
| 6. Clip indicator | 13. Power ON/OFF switch. | |
| 7. Microphone input signal indicator. | 14. Volume control. | |

Attention :Before changing the MODE switch, please power the speaker off to avoid possible damage.

Installation Accessories(Optional)

1. Speaker stand



2. U-Bracket

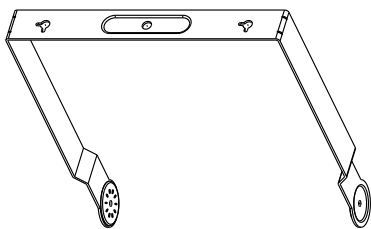

Installation Reference

1.Reference A

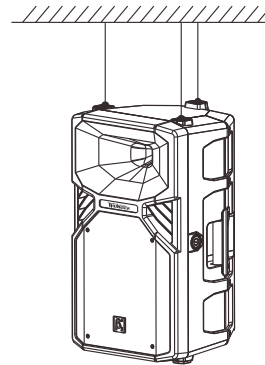

2.Reference B

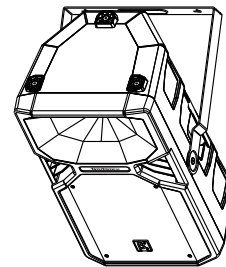

3.Reference C

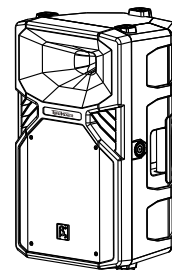

4.Reference D

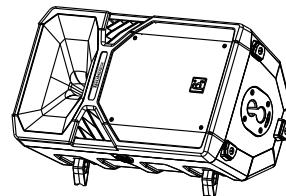

5. Speaker stand application

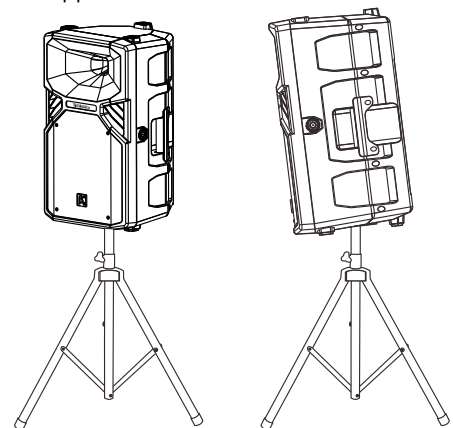

Warning: Make sure the mounting accessories safety factor not less than 5:1 or meet the local standard during installation .

Specification

Frequency response(-3dB):	50Hz-20kHz
Max.SPL:	130dB
Dispersion(H × V):	90° × 60°
Transducer:	1 × 12" Woofer 1 × 1.7" Compression Driver
Rated impedance:	8 Ohms
Connector:	XLR for input, XLR for output
Input:	Channel one (Mic/Line) balanced input
Input impedance(line):	20Kohm balanced input, 10Kohm unbalanced input
Input level:	0 dBV (0.775V rms, 1.0 V peak)Line-100Hz
Input overloading level:	Maximum input level 8 V peak
Wire connection:	pin 1: ground; pin2: signal +; pin3: signal -
Heat radiation:	Forced air-cooled drives
Power cable:	IEC 3 pin power connector
Safety voltage range:	AC 220V-240V~, 50/60Hz (or AC 110V-120V~, 50/60Hz)
Amplifier power output:	1100W
Cabinet:	Polypropylene injection moulding
Flying/ Mounting accessories :	8 × M8 hanging point, SMART pole mount system
Handle:	One side, one rear
Painting:	Powered coated grill
Cabinet dimension(W x D x H):	368 × 349 × 630mm(14.5 × 13.7 × 24.8in)
Packing dimension(W x D x H):	420 × 410 × 720mm(16.5 × 16.1 × 28.3in)
Net weight:	21.5kg(47.3 lb)
Gross weight:	23.5kg(51.7 lb)

Frequency response curve

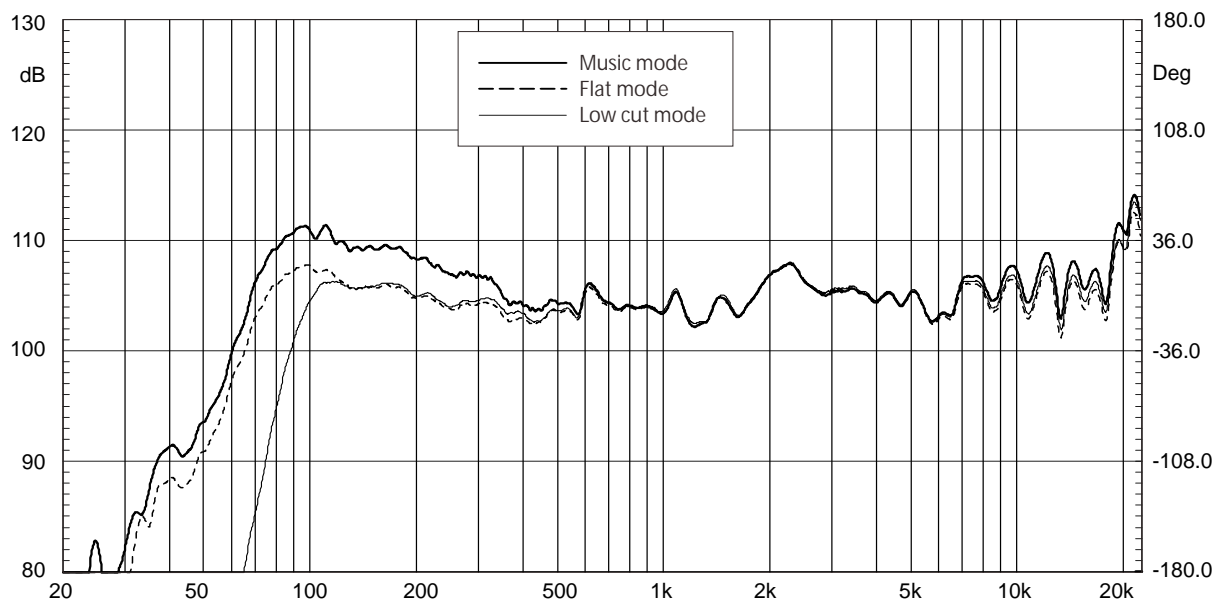

2D Dimension

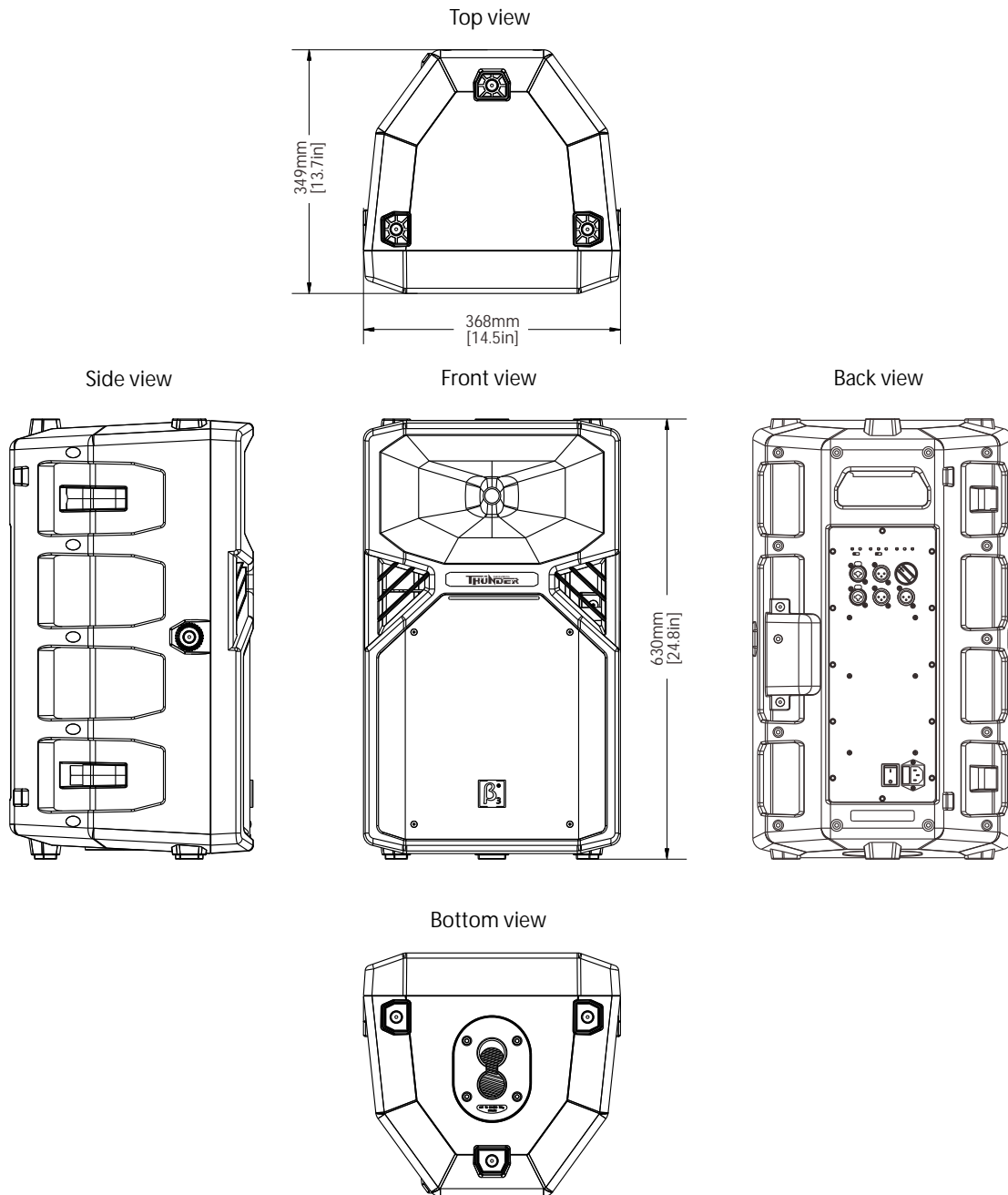

Notes:



Beta Three