

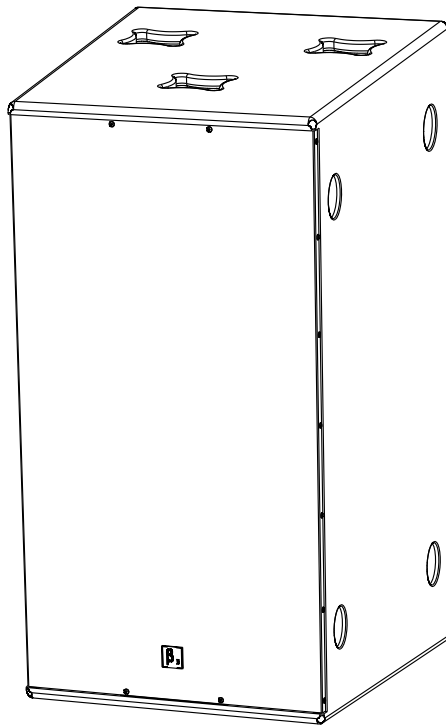

Beta Three

TLB-218





CONTENTS

INTRODUCTION	-----	1
FEATURES	-----	1
SPECIFICATION	-----	1
ACOUSTIC CHARTS	-----	2
INSTALLATION	-----	4
DIMENSIONS	-----	4
LIMITED WARRANTY	-----	5

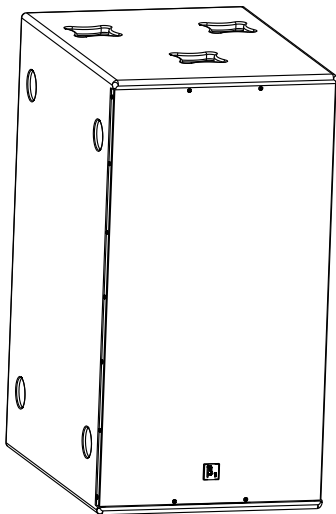

TLB-218

INTRODUCTION

3 TLB Series are designed for the entertainment sound reinforcement, including Disco hall, performance bar, night club, touring performance.

TLB Series are developed and produced by the combination of the latest computerized simulation design technology, the latest loudspeaker materials and manufacturing technology. The transducers adopt the most optimized magnetic circuit with high magnetic energy, low distortion and excellent ventilation.

LF transducers use nonlinear thickness long fabric paper cone with special painting cloth surrounding and high power sandwich type 100mm diameter voice coil and 220mm diameter magnetic are used for subwoofer to effectively prevent the distortion occurrence.

FEATURE

With computer optimize simulation design to get better frequency and phrase features.

Two transducers high sensitivity speaker.

Two 18 inches high efficiency subwoofers.

Driven by one amplifier.

Suitable for the entertainment sound reinforcement, including Disco hall, performance bar, night club, touring performance.

Used for high quality output replaying music working with full range speaker.

SPECIFICATION

Transducer	LF: 18" x 2
Frequency Response(-3dB)	35Hz-1.8kHz
Sensitivity(1m/1W)	102dB
SPL(1m)	134dB
Max.SPL(1m)	140dB
Power(RMS)	1600W
Power(Program)	3200W
Power(Peak)	6400W
Rated Impedance	4
DC Impedance	2.6
Crossover Point	< 250Hz
THD	< 3%
Input Connectors	NL4 x 2
Net Weight	85kg
Gross Weight	90kg
Dimensions (W x D x H)	567 x 786 x 1075mm
Packing Dimensions(W x D x H)	1185 x 895 x 685mm

TLB-218

FREQUENCY RESPONSE

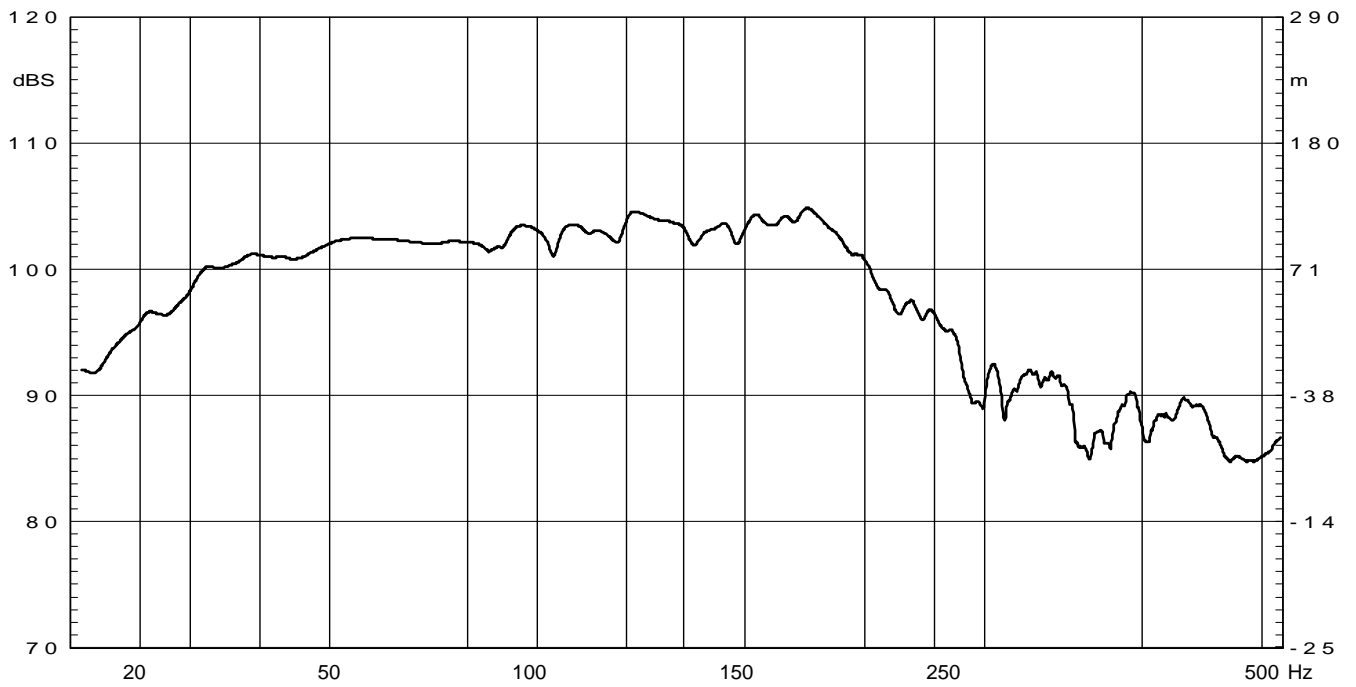

IMPEDANCE RESPONSE

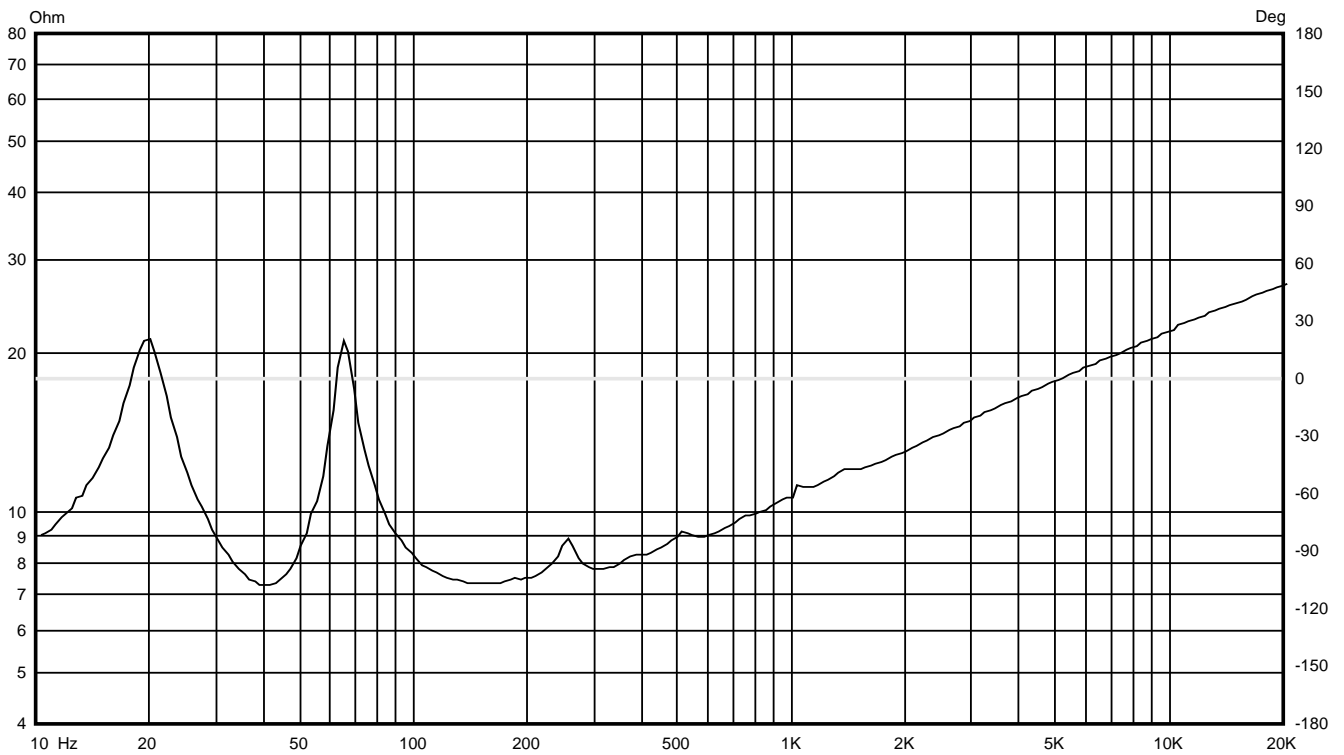

WATERFALL

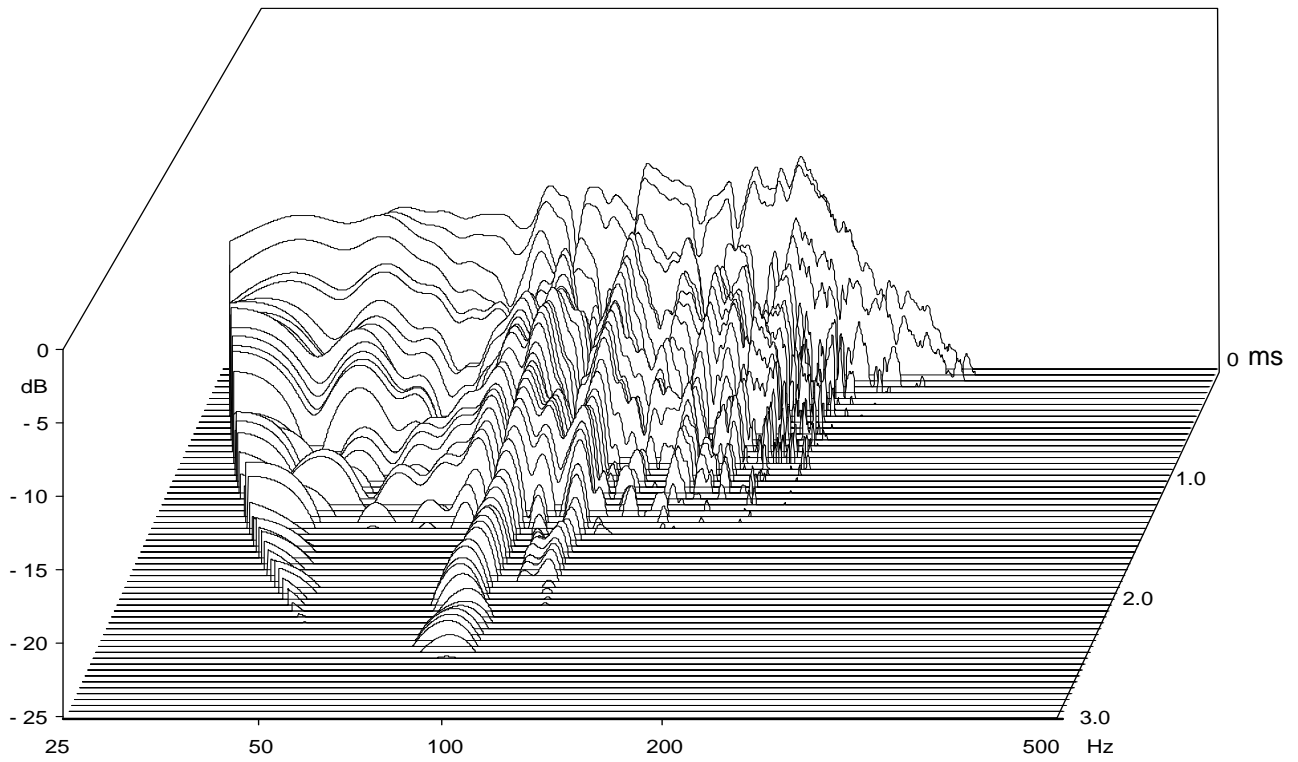

THD

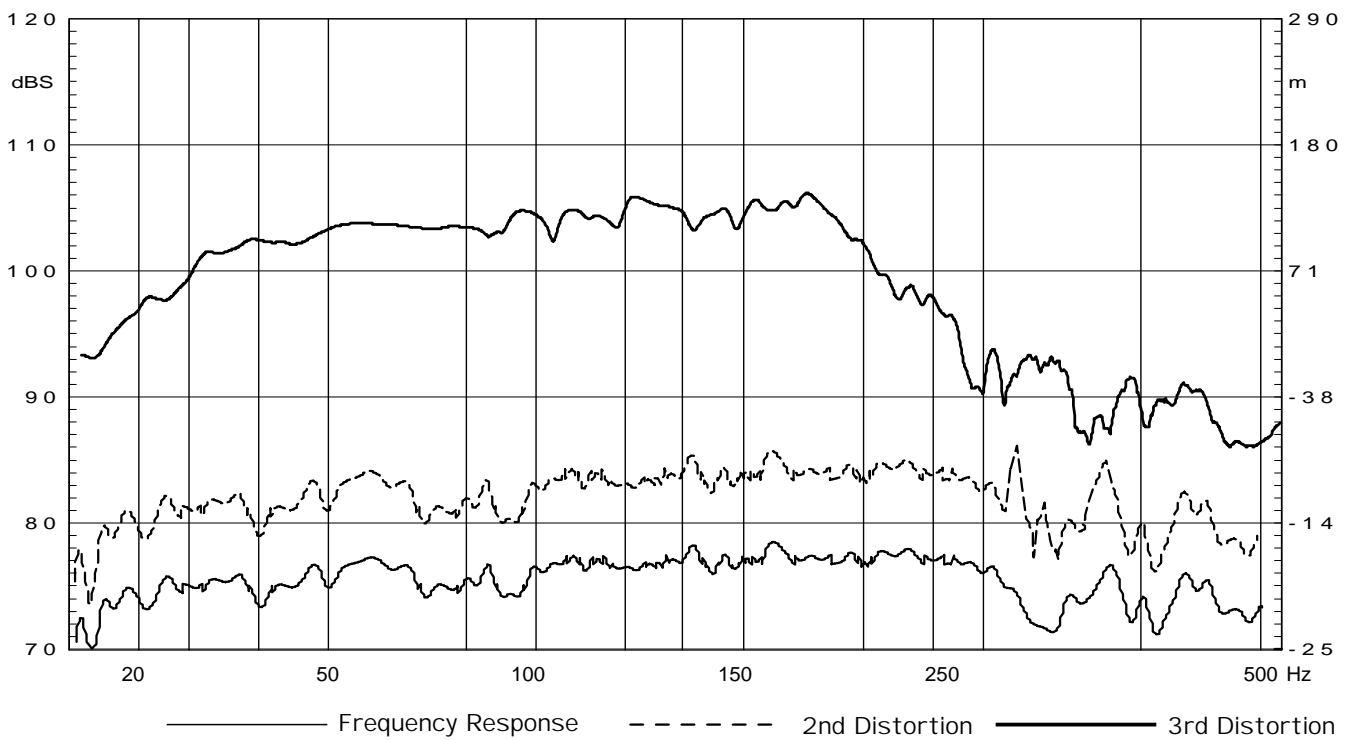

DIMENSIONS

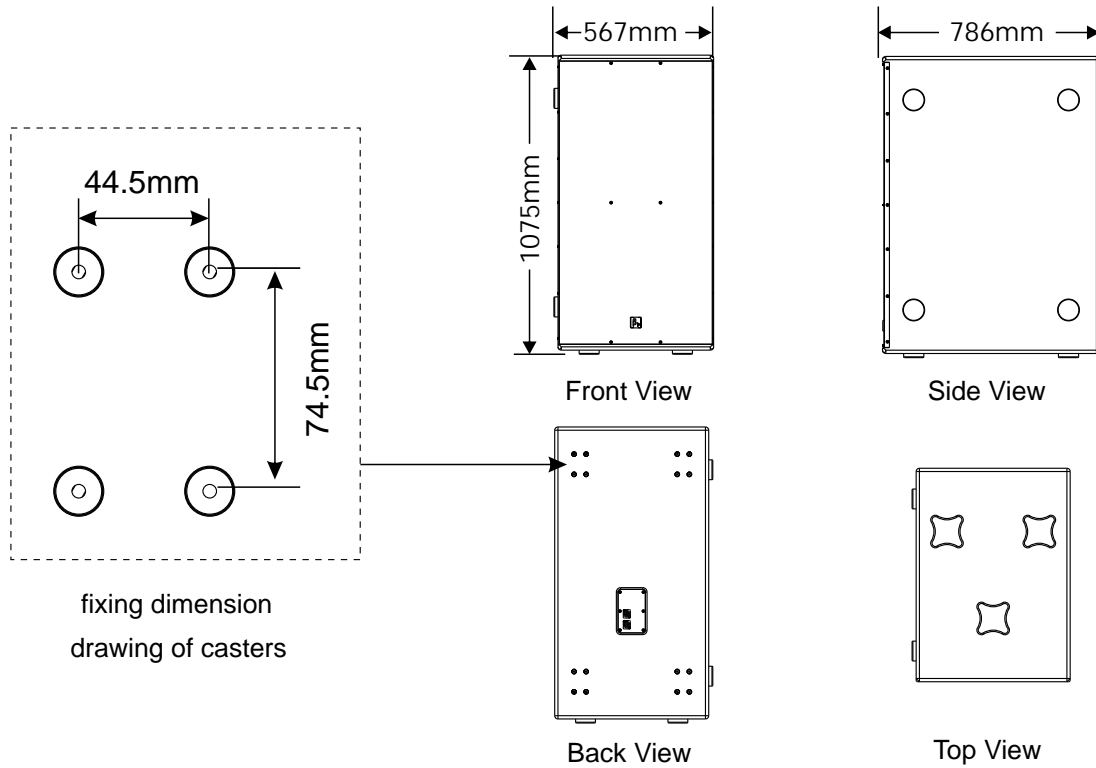

ACCESSORIES

Optional accessories:

- Casters: 100*34mm 4 PCS
- Screws:M8*30 inner hexangular 16PCS
- Spring gasket: 8(Black) 16PCS
- Flat gasket: 8(Black) 16PCS
- PE bag:4PCS
- Packaging: 1PCS

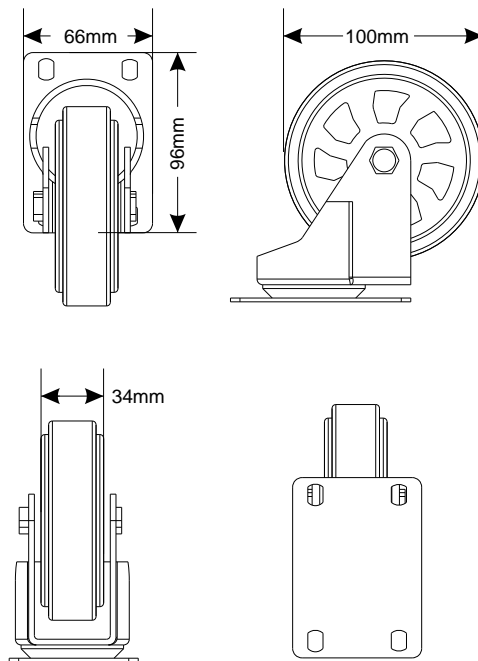

LIMITED WARRANTY

If malfunction occurs during the specified warranty period from the date of original purchase, the product will be repaired or replaced without charge by Elder Audio.

The Limited Warranty does not apply to:

- (a) exterior finish or appearance;
- (b) certain specific items described in the individual product data sheet or owner's manual;
- (c) malfunction resulting from use or operation of the product other than as specified in the individual product data sheet or owner's manual;
- (d) malfunction resulting from misuse or abuse of the product;
- (e) malfunction occurring at any time after repairs have been made to the product by anyone other than Elder Audio Service or any of its authorized service representatives.

To obtain warranty service, customer must deliver proof of purchase of the product in the form of a bill of sale or receipt invoice.

TLB-218 Speakers and Speaker Systems are guaranteed against malfunction due to defects in materials or workmanship for a period of three (3) years from the date of original purchase. The Limited Warranty does not apply to burned voice coils or malfunctions such as cone and/or coil damage resulting from improperly designed enclosures. Additional details are included in the Limited Warranty statement.

TLB-218 Accessories are guaranteed against malfunction due to defects in materials or workmanship for a period of one (1) year from the date of original purchase. Additional details are included in the Limited Warranty statement.

TLB-218 Flying Hardware (including enclosure-mounted hardware and rigging accessories) is guaranteed against malfunction due to defects in materials or workmanship for a period of one (1) year from the date of original purchase. Additional details are included in the Limited Warranty statement.

Specifications are subject to change without notice.

